

Box Header 2.0 mm

90° & SMT Series

SPECIFICATIONS

Current Rating: 2 A
 Insulator Resistance: 3000 MOhm min.
 Dielectric Withstanding: AC 500 V
 Operating Temperature: -40°C ~ +105°C
 Soldering Temperature: 260°C for 3~5sec. max
 Contact Material: Copper Alloy
 Insulator Material: Polyester, UL 94V-0
 Standard: P.B.T.
 Finish: Tin, Gold or Duplex Plated
 Standard: Gold Flash all over
 Note: Duplex Plating: Gold Plated on contact area, Tin on solder area

B413-R2GP-D030-XX

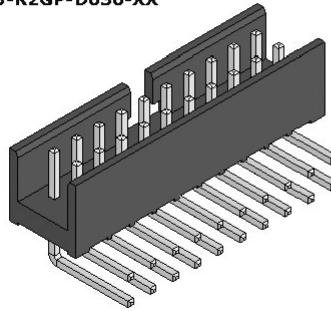

B413-M4GN-D090-XX

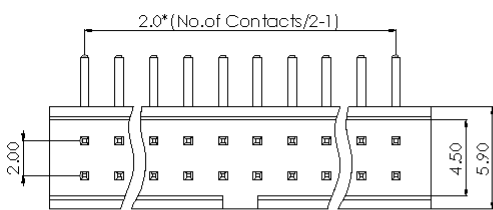
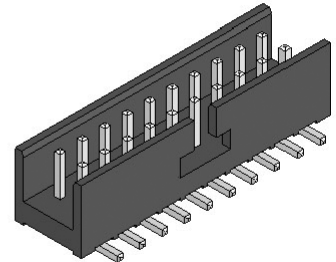

[B413]

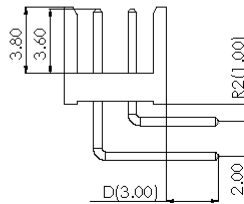
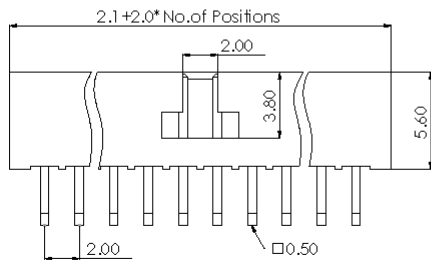
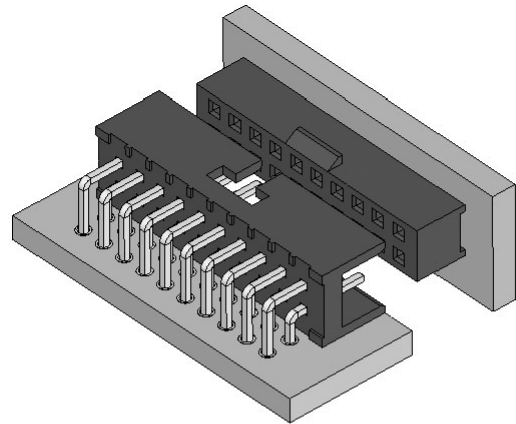
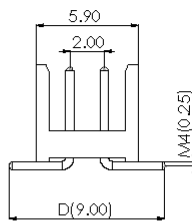

[B413]

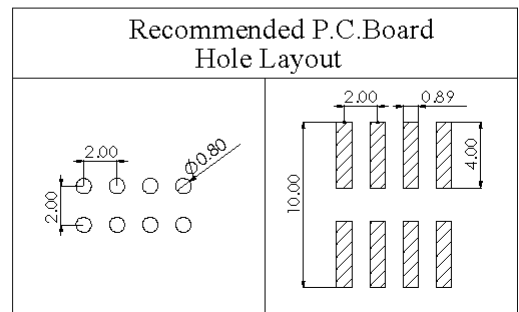

How to order

Unit: mm

Series	Connector Type	Contact Plating	Material	Pin Length mm	Number of Contacts
BXXX	X	X	X	DXXX	XX
B413: B/H 2.00 H: 5.60 Dual Row	R: Right Angle R2: 1.00 : : M: SMT Type M4: 0.25 : :	G: Gold Flash T: Tin Plated A: 10U" Gold B: 15U" Gold C: 20U" Gold ⊙ Duplex Plating D: Gold Flash/Tin (Standard: G)	P: PBT N: Nylon-6T	R-D D030 M-D D090	(10 TO 68 Contacts)